

TIRE CHANGER

COMPUTERIZED AUTOMATIC TIRE CHANGER

Capture.4 Premium Leverless, computerized, incl. pneumatic bead pusher and wheel lift, passenger car, rim diameter: 10" - 34".
New: Smart-Lock for rim clamping included!

+ 10" - 34" fully automatic tire changer that can perform all mounting and removal work without touching by hand
+ Leverless - No mounting lever required



Rotating pneumatic bead pusher arm

4 working arms

User-friendly operating unit for manual operation

Retaining ring for mounting paste included

Air treatment unit (water separator, pressure control, and lubrication)

With patented self locking clamping plate
Patented extra-grip self locking plate for central wheel mount:
- Automatically increases the clamping pressure during rotation
- Three adjustable working position

Pneumatic wheel lift: Raises the wheel from the floor to central clamping

Patented Butler mounting tool for stress-free mounting and removal of all tires and rims (standard, UHP, RunFlat)
Upper mounting head of non-scratching material for damage-free work on the rim near the edge (zero stress effect)
Lower mounting head:
- Made of non-scratching material
- For mounting the lower bead without a mounting iron

Electric motor with inverter and speed limiter (protection of the tire in case of excessive forces) for individual speed control (0 - 16 rpm)

Storage area for depositing accessory parts, valves, and tools

HIGHLIGHTS IN DETAIL

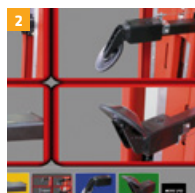
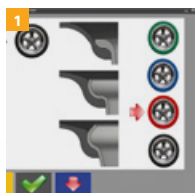

1 In the automatic mode you only have to enter the wheel dimension with the keyboard, confirm it and move the valve sensor to the 12 o'clock start position. By pressing the start button, the Capture4 is ready for work in automatic mode and positions all tools (2 mounting tools and 2 bead breaker disks rolls) in the correct work positions.

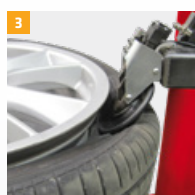
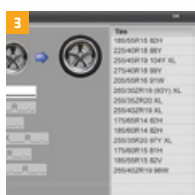

2 3 automatic programs:
- Assembly/ Disassembly (standard)
- Disassembly (for example for vehicle recyclers)
- Assembly (for example for vehicle manufacturers)
3 Database can be personalized
4 Equipped with the exclusive active Butler sensor system and computer-controlled sequence program by input and storage of customer-specific tire dimensions

ACCESSORIES ON REQUEST

+ Universal flange for wheels without center hole, suitable also for reverse mounted wheels

Capture.4 Premium

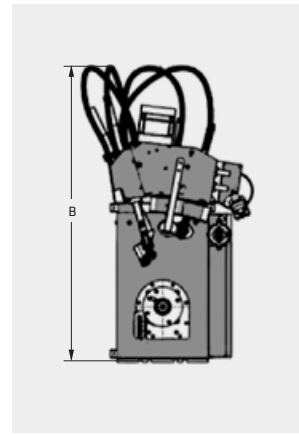
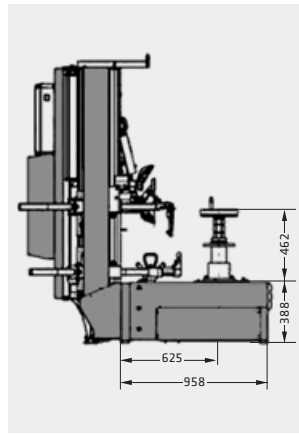
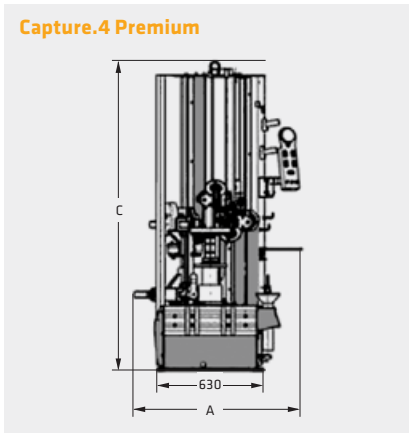

Model	CAPTURE.4 Premium
Clamping range	10" - 34"
Rim width max.	15"
Wheel diameter max.	1370 mm
Wheel weight max.	80 kg
Automatic bead-breaking movement	X
Bead-breaking force	1200 kg
Rotation speed	0-16 rpm
Torque max.	1373 Nm
Power inverter motor	1,5 kW
Motor power	0,75 kW
Compressed air supply	8-10 bar
Mains frequency	50/60 Hz
Mains voltage (AC)	200/265 V
Phases	1
Fuse protection	16 A träge
A Width	1590 mm
B Depth	1915 mm
C Height	1842 mm
Weight	510 kg
Article number	810110

SCOPE OF DELIVERY

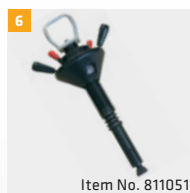
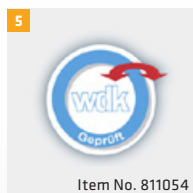
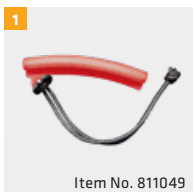

- 1 Rim flange plastic protection
- 2 Magic cord with traction
- 3 Bead protection foils
- 4 Pneumatic bead pusher and pneumatic wheel lift (811002 / 811072 / 811074)
- 5 WDK certificate
- 6 Quick-clamping lock
- + Upper mounting head for convex rim (811606)
- + WulstBoy with pulling device Capture (G1000A124)